

# Chains of motley gems—and their Wiener indices

Bo-Yin Yang and Yeong-Nan Yeh\*

\* In homage of my beloved late Teresa Teng who has supported me spiritually through years

**Abstract.** Looking into the problem of determining the Wiener indices of mixed polygonal chains, we find general recursion algorithms applicable to all polygonal chains, yet simple enough for hand calculation. For chains composed of even-sided polygons only, we derive pithy explicit formulas. In the process, we also find simpler proofs for previously known formulas.

**Keywords:** polygonal chain, Wiener index

## 1. History

**Definition 1.** For a connected graph  $G = (V, E)$ , and its distance function  $d : V \times V \rightarrow \mathbb{N} = \{0, 1, 2, 3, \dots\}$ , we define the *Wiener index*:

$$\mathcal{W} = \mathcal{W}(G) \equiv \sum_{\{u,v\} \subset V} d(u, v).$$

For any given point  $u$  in  $V = V(G)$ , we define

$$\mathcal{W}(u|G) \equiv \sum_{v \in V} d(u, v),$$

sometimes called the *partial Wiener index* of  $u$  (with respect to  $G$ ).

In short, the Wiener index of a graph is the sum of distances between pairs of its vertices. Obviously we have  $\mathcal{W} = \frac{1}{2} \sum_{u \in V} \mathcal{W}(u|G)$ .

This quantity was first used in 1947 by Harold Wiener in his seminal article [35] (and used in a later series of articles, see [36]–[38]) where he came up with this surprisingly good approximation for the boiling points of high alkanes:

$$\text{b.p.} \approx \alpha \mathcal{W} + \beta w_3 + \gamma,$$

with  $\alpha$ ,  $\beta$ ,  $\gamma$  being empirical constants,  $\mathcal{W}$  the Wiener index of the molecular graph of the alkane, and  $w_3$  the 'path number' (number of vertex pairs 3 apart in the graph).

After Wiener, applications of graph theory to chemistry lay dormant for a decade or so, and not until the concept was rediscovered in 1962 and used to estimate the critical constants of alkanes did the Wiener index really resurface. Wiener's original definition only applied to alkanes (the total number of carbon-carbon bonds between all pairs of carbon atoms), but it is easy to generalize to all molecular graphs. Eventually, Hosoya pointed out [13] in 1971 the usefulness of treating the Wiener index as a quantity associated with a molecular graph only and basically gave the present definition.

In the '70s and '80s, numerous studies of the Wiener index were undertaken, both from the chemical and mathematical angles, and it is surprising therefore that a bewildering array of names for this concept had been used as no one seems to have bothered checking the literature before inventing his own terminology. Those with a graph theory bent called it the *total transmission* like Šoltés (see [33]) or *gross(total) status* like Harary ([11] & [12]); some like Plesnik [25] and Rouvray [27]-[30] used descriptions, (*sum of distances* and *sum of the distance matrix elements* resp.), obviously both being twice the Wiener index; also used are *total distance* (Mohar [22]) and *total weight* (Teh and Shee, [34]). However 'Wiener index' or 'Wiener number' seems to have stuck as the most popular.

Eventually, the Wiener index  $\mathcal{W}$  became one of the best (also likely the most often used) descriptors of molecular shape deducible from the molecular graph. We recommend, in addition to those specifically referred to below, [1], [3], [5], [17], [20], [21], [24], and [31], for those interested. Cites to most of the chemistry can also be found in the survey [8].

It should be fairly easy to see that the Wiener index of the molecular graph provides a measure of the compactness and the extent of branching in the molecule. Indeed, those physical and chemical properties that depends primarily on the intermolecular forces<sup>1</sup> (whose primary determining factor is the molecular volume-to-surface ratio) or the extent of branching in the skeleton are usually well linearly correlated with  $\mathcal{W}$ . For most families of hydrocarbons whether cyclic or acyclic, aromatic or aliphatic, these form an impressive list. As summarized in [2], these include heats of formation, atomization, isomerization, and vaporization; density, boiling point, critical pressure and temperature, refractive index, surface tension, velocity of sound propagation, and viscosity. In polymer chemistry, the Wiener index have been used successfully as predictors for physical properties such as melting points and others such as  $\pi$ -electron energies in conjugated polymers.

Since both pharmacology and material science often involve physical and chemical properties having to do with intermolecular forces, it is not surprising that Wiener

---

<sup>1</sup>The fact that  $\mathcal{W}$  is correlated with so many physico-chemical properties of hydrophobic molecules means that it just has to be a rough measure of intermolecular forces. Recently it was shown that for medium-sized hydrocarbons of various families, both of the most widely used measures of intermolecular forces, Pitzer's acentric factor [26] and the Van der Waals  $a$ -coefficient have linear correlation coefficients higher than 90% to the Wiener index.

indices also found applications to both fields. For the former, Lukovits showed that the Wiener index of certain pharmacologically significant families of compounds has very strong correlations and their respective cytostatic, antihistaminic, and estrogen-bonding activities; recently, he provided a good estimator of the partition coefficient to water for certain compounds (see [18]), a vital parameter in forecasting pharmacological utility. For the latter,  $\mathcal{W}$  was recently used to characterize crystal defects and stability of lattices.

Lots of water has passed under the bridge and by now Wiener indices are relatively familiar objects to both graph theorists and theoretical chemists, and connections to other branches of mathematics have been found (e.g. [32]). Algorithms for computing the Wiener index for specific types of graphs are known for some time (see [23] for a good summary) and in some specific instances linear-time algorithms can be found. However, chemists are more interested in methods that lead to relatively simple general expressions for Wiener indices of families of molecules, especially that enables calculation by paper-and-pencil. For the case of a tree  $G = (V, E)$ , Wiener [35] himself provided this pretty formula:

$$\mathcal{W}(G) = \sum_{e \in E} n_1(e)n_2(e), \quad (1.1)$$

where  $n_1(e), n_2(e)$  are the number of vertices on either side of edge  $e$ .

Merris and McKay [19] independently came up with another which connects Wiener indices to spectra of Laplacian matrices of trees. Let  $N = |V|$  and  $\lambda_1 \geq \dots \geq \lambda_{n-1} \geq \lambda_n = 0$  be the spectrum of the Laplacian matrix  $L = D - A$  of the graph  $G$ , then

$$\frac{\mathcal{W}(G)}{N} = \sum_j \frac{1}{\lambda_j}. \quad (1.2)$$

Gutman (see [8]) proved yet a third nice formula:

$$\mathcal{W}(G) = \binom{n+1}{3} - \sum_{\substack{\deg x \geq 3 \\ x \in V}} \left( \sum_{j>k} n_j(x)n_k(x) \right), \quad (1.3)$$

where  $n_1 \geq n_2 \geq \dots$  are the number of vertices in the components resulting the deletion of  $x$  from  $G$ .

Other facts about the Wiener indices of trees can be found in [8].

For graphs that are not trees (usually representing cyclic molecules), there isn't nearly so much in the way of general results aside from the formulas for Wiener indices of composite graphs by Gutman and Yeh [10]. Most results have been worked out on a case-by-case basis and open problems abound.

One such had been the computation of Wiener indices of polygonal graphs, especially chains. For a long time, calculations involve long computer runs that sometimes even give the wrong result, and the only noteworthy results were those of Gutman *et al* (see [6] & [7]) on hexagonal chains, which still were not closed-form. Recently,

the authors have found closed-form solutions which indeed allow paper-and-pencil calculations for hexagonal [16] and pentagonal chains [39] (the latter an entirely open problem despite much effort), as well as for regular two-dimensional polygons patterns [15]. Here we give a general closed-form formula for all chains of even-sided polygons (Section 2) and demonstrate (via examples) a suitably easy algorithm for 'straight chains' (Section 3) and from it for any polygonal chain (Section 4).

## 2. Finding the Wiener index of a generic even chain

To begin with, we need to define our terms:

**Definition 2.** A *motley (polygonal) chain* is a graph of concatenated polygons (cycles sharing an edge) in which (for the moment) no vertex has degree more than 3.

**Definition 3** (Representation of motley chains). Given  $n$  ordered pairs of non-negative integers  $S = (a_1, b_1), \dots, (a_n, b_n)$ , we create a graph as follows: take the graph  $P_2 \times P_n$  (noting it to be composed of  $n$  adjacent squares joined up side by side) and subdivide the  $j$ -th upper and lower edges by inserting  $a_j$  and  $b_j$  extra vertices respectively. We will call it the *motley chain* associated with  $S$  and write it as  $M(S)$  or, when context permits, just  $S$ . The Wiener index of the graph  $M(S)$  will be denoted by  $\mathcal{W}(S)$ . Obviously, as long as two sequences only differ in the first and last pairs with the sums  $a_1 + b_1$  and  $a_n + b_n$  identical, the associated graphs will remain the same. Hereafter, we will represent such a equivalence class as:

$$\left\langle (a_1 + b_1) \ a_2 \ a_3 \ \dots \ a_{n-1} \ (a_n + b_n) \right\rangle.$$

A motley chain clearly determines its own representation as above, uniquely up to the reversal of the order of the sequences, or the exchange of the numbers in each pair (both of these being involutions, i.e., at most 4 distinct representations in a  $K_4$  group).

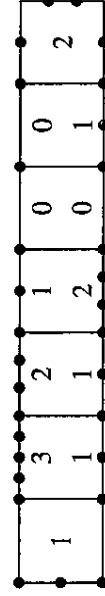

Figure 1. A "chain of motley gems."

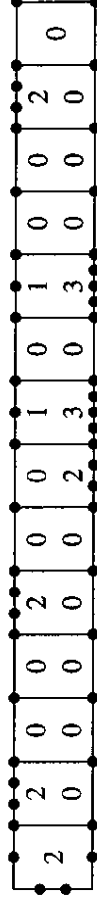

Figure 2. An even motley chain.

Figures 1 and 2 show how to make the construction as defined above. Thus, the work in [16] and [39] handle respectively the cases where each polygon is a hexagon and a pentagon (or when each pair of integers  $(a_i, b_i)$  adds up to 2 and 1) respectively.

In the special cases where each of the polygons has an even number of sides (or the each pair of numbers are of two of the same parity—see Figure 2), there is an alternative representation:

**Definition 4** (Alternative representation of even motley chains). We correspond each sequence  $E \equiv k_0, (k_1, j_1), (k_2, j_2), \dots, (k_n, j_n), k_{n+1}$ , (where for every  $i$  we have  $k_i \in \mathbb{P}$  and  $j_i \in \mathbb{Z}$ ,  $|j_i| < k_i$ ) with the motley chain  $M(S)$ , where

$$S \equiv \hat{E} \equiv \left( 2(k_0 - 1) \begin{matrix} k_1 - j_1 - 1 \\ k_1 + j_1 - 1 \end{matrix} k_2 - j_2 - 1 \dots k_n - j_n - 1 \begin{matrix} k_n - j_n - 1 \\ k_n + j_n - 1 \end{matrix} 2(k_{n+1} - 1) \right).$$

To make the notation more compact, we will also write this as (see Figures 2 and 3)

$$E = k_0(k_1)_{j_1}(k_2)_{j_2} \dots (k_n)_{j_n}k_{n+1}$$

and subscript 0's, especially when the corresponding  $k_i$  is 1, will often be omitted as well—see Figure 3. We will call  $K \equiv \sum_{j=0}^{n+1} k_j$  the *total length* of the even motley chain.

This even motley chain is encoded as

$$22_{-1}12_{-1}12_{+1}3_{+1}13_{+1}112_{-1}1$$

is the same as the one just seen:

$$\langle 20200101002 \ 0 \rangle.$$

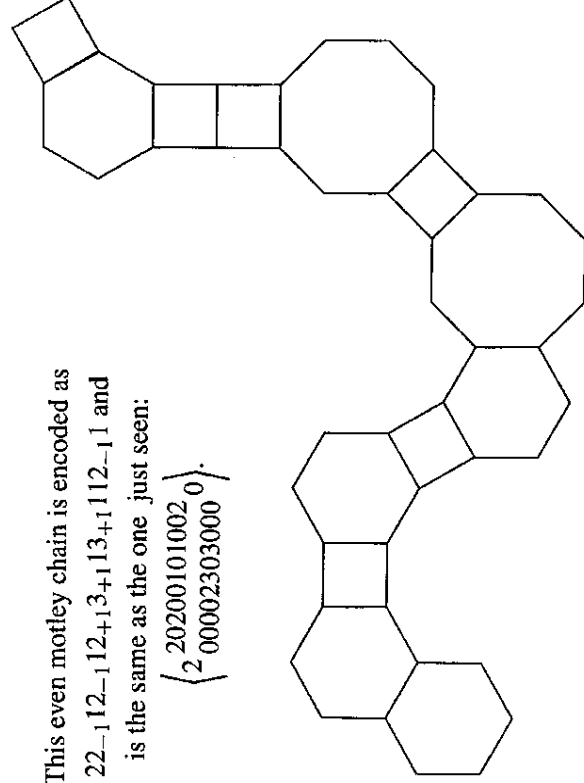

Figure 3. The last-shown motley chain in the eyes of chemists.

Using methods reminiscent of those in [15], we will first establish a base value from which we can evaluate deviations; for even motley chains this base value is obvious—it must be the Wiener index of a straight chain. Before we do that, however, we need a small lemma

**Lemma 1.** *The Wiener index of a chain of  $n$  squares is*

$$\mathcal{W}((1)^n) = \mathcal{W}(P_{n+1} \times P_2) = \frac{1}{3}(n+1)(n+3)(2n+1),$$

which differs from the Wiener index of a  $2(n+1)$ -gon (or  $2(n+1)$ -cycle) by  $2\binom{n+1}{3}$ .

*Proof.* Theorem 4 of [8] gives the Wiener index for the Cartesian product. That  $\mathcal{W}(C_{2n}) = n^3$  has been known from long ago. □

**Theorem 1** (Straight evens). *For a ‘straight’ even motley chain  $E$ , represented as*

$$E \equiv k_0 k_1 k_2 \dots k_n \equiv \left( 2(k_0 - 1) \begin{matrix} k_1 - 1 & k_2 - 1 & \dots & k_n - 1 \\ k_1 - 1 & k_2 - 1 & \dots & k_n - 1 \end{matrix} 2(k_{n+1} - 1) \right),$$

and has among its  $(n+2)$  polygons a total of  $n_4$  squares,  $n_6$  hexes,  $n_8$  octagons, etc. and total length  $K = \sum_i (n_{2i+2} i)$ , we have as the expression for its Wiener index:

$$\mathcal{W}(E) = \frac{1}{3}(K+1)(K+3)(2K+1) + \frac{1}{3} \sum_{j=0}^{n+1} k_j(k_j+1)(k_j-1) \quad (2.4)$$

$$= \frac{1}{3}(K+1)(K+3)(2K+1) + 2 \sum_i n_{2i} \binom{i}{3}, \quad (2.5)$$

which is independent of the order in which the polygons are arranged.

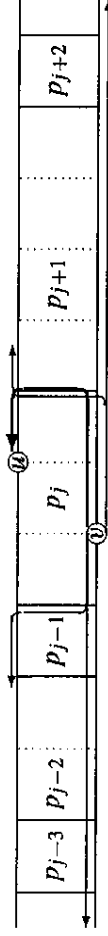

Figure 4. Wiener indices of straight even motley chains.

*Proof.* We compare the chain  $E$  to the even chain  $1^K$  (a chain of squares). See Figure 4: we can see that for any two vertices  $u, v \in E$ , either  $d_E(u, v) = d_{1^K}(u, v)$  or  $u$  and  $v$  belong to the same polygon  $p_j$  in the chain. Ergo:

$$\begin{aligned} \mathcal{W}(E) &= \sum_{\{u,v\} \in \binom{E}{2}} d_E(u, v) \\ &= \sum_{\{u,v\}} d_{(1^K)}(u, v) + \sum_{j=0}^{n+1} \sum_{\{u,v\} \in P_j} [d_E(u, v) - d_{(1^K)}(u, v)] \\ &= \mathcal{W}(P_{K+1} \times P_2) + \sum_{j=0}^{n+1} [\mathcal{W}(C_{2k_j+2} - \mathcal{W}(P_{k_j+1} \times P_2))]. \end{aligned}$$

and the final substitutions follow from the lemma. □

Having deduced the base value, we can obtain results for *any* even motley chain by ‘straightening’ it out in stages! Take any even chain

$$E = k_0(k_1)_{j_1}(k_2)_{j_2} \dots (k_n)_{j_n} k_{n+1}$$

and define the ‘intermediate stages of straightening’:

$$E_\ell \equiv k_0(k_1)_{j_1}(k_2)_{j_2} \dots (k_\ell)_{j_\ell}(k_{\ell+1})_0(k_{\ell+2})_0 \dots (k_n)_0 k_{n+1}.$$

Obviously, we have

$$\mathcal{W}(E) = \mathcal{W}(E_0) - \sum_{i=1}^n [\mathcal{W}(E_{i-1}) - \mathcal{W}(E_i)], \tag{2.6}$$

and therefore we need only know each  $\mathcal{W}(E_{i-1}) - \mathcal{W}(E_i)$  in order to find out  $\mathcal{W}(E)$ . For convenience, we will use these notations so as to be parallel to the usage of [16] and [39]: for each stage of the ‘straightening’ we mark out the vertices  $u_0$  and  $u_1$ , and  $v_0, v_1, \dots, v_\ell$  where  $\ell$  is the number of sides of  $p_j$ , the polygon in question, minus three (see Figure 5). The partial Wiener index  $\mathcal{W}(v_i, M(S))$  is written as  $\mathcal{X}_i(S)$ .  $T$  will refer to the portion of straight even chain at the tail.

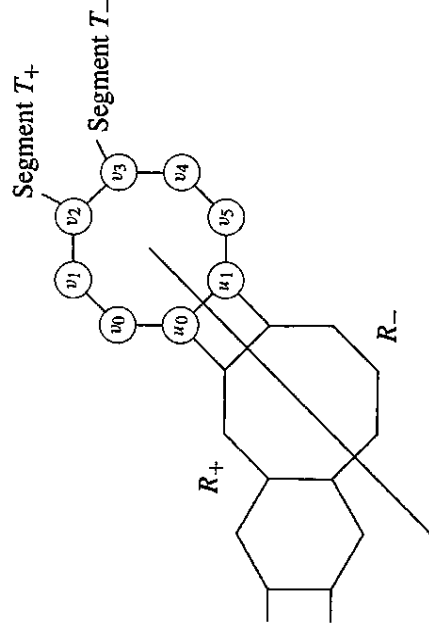

Figure 5. Marking the advance vertices.

It should be clear that some of the vertices in the ‘unstraightened’ part of  $S$  will have shortest paths into  $T$  through  $u_0$  and some through  $u_1$ ; to be quite precise, we can draw a figurative border down the middle of the next polygon and everything on the same side of  $u_1$  will have the minimum distance access route through  $u_1$ , and vice versa, and we will call the first part  $R_+$  and the other  $R_-$ , just to mark them (in Figure 6, these are colored light gray and black respectively). It should also be clear that there is a total of  $2 \sum_{m=j+1}^{n+1} k_m$  vertices in  $T$ , and we label the ‘top’ half  $T_+$  and the ‘bottom’ half  $T_-$  as in the Figure 5.

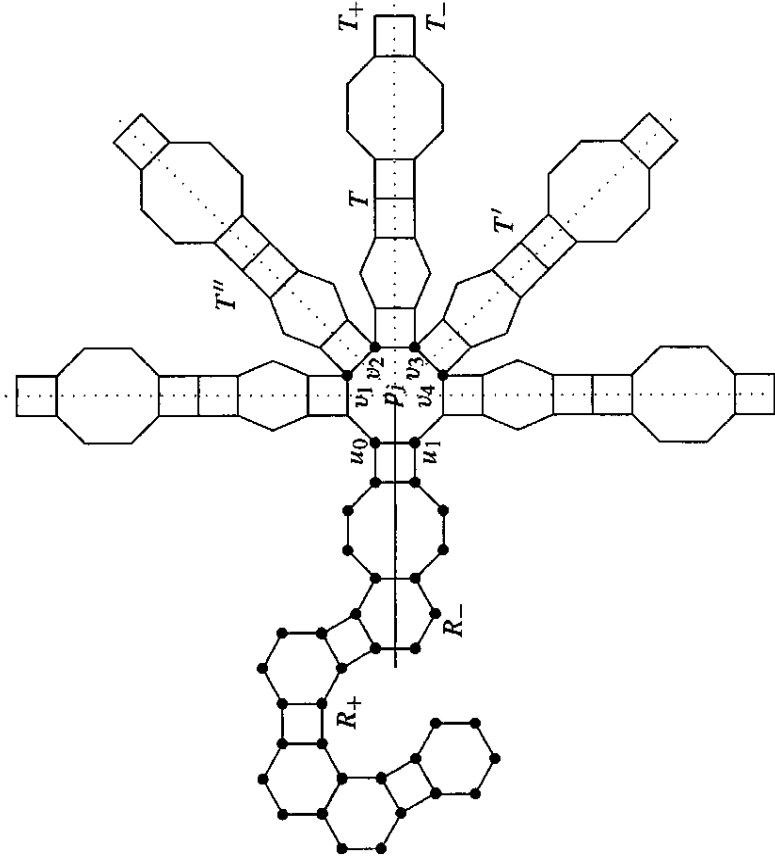

Figure 6. During the process of straightening!

We can see from Figure 6 that in fact as far as Wiener indices are concerned, the polygon  $p_j$  itself doesn't matter. Of the portion  $R$  remaining unstraightened, we can see that when the chain is 'bent' such that  $T$  goes into  $T'$ , each point in  $R_+$  gets closer to each point in  $T_-$  by one, and farther away from each point in  $T_+$  by one—for no net difference; however, each point in  $R_-$  gets closer to any point in the tail by one. Hence, we know that the difference in Wiener indices is  $|R_-| \times |T|$ . Similarly, when we rotate  $T$  into  $T''$ , the Wiener index decreases by  $|R_+| \times |T|$ .

What about bigger turns? For each move after the first, we have the *entire*  $R$  approaching the whole of  $T$  and the net decrease in Wiener index is  $|R| \times |T|$ . Notice that bigger turns are impossible for chains of just hexagons (and squares)—this last case only become relevant in the case of an octagon or larger.

The above can be summed up succinctly thus:

**Lemma 2.**

$$\mathcal{W}(E_{i-1}) - \mathcal{W}(E_i) = \begin{cases} |T||j_i|R_+| + (j_i - 1)|R_-|, & \text{if } j_i > 0, \\ |T|((-j_i - 1)|R_+| - j_i|R_-|), & \text{if } j_i < 0. \end{cases} \quad (2.7)$$



Given an even chain  $E = k_0(k_1)_{j_1}(k_2)_{j_2} \dots (k_n)_{j_n}k_{n+1}$  of whose  $j$ 's precisely those with the indices  $i_1, i_2, \dots, i_m$  are non-zero. We define more notations:

$$K_\ell \equiv \sum_{h=0}^{i_\ell-1} k_h, \text{ (and } K_0 \equiv 0,)$$

$$K'_\ell \equiv \sum_{h=i_\ell+1}^{n+1} k_h,$$

$$\tau_\ell \equiv (2|j_{i_\ell}| - 1)K_\ell + \text{sgn}(j_{i_\ell}j_{i_{\ell-1}})K_{\ell-1}.$$

**Theorem 2** (General evens).

$$\mathcal{W}(E_0) - \mathcal{W}(E) = 2 \sum_{h=1}^m K'_\ell \tau_\ell, \tag{2.8}$$

where  $\mathcal{W}(E_0)$  is given by Equation 2.5.

*Proof.* In the  $i_\ell$ -th stage of 'straightening out',  $|T|$  in Equation 2.7 is obviously  $2K'_\ell$ . It remains to calculate  $|R_+|$  and  $|R_-|$ . Again from Figure 6 we can see that  $|R|$ , the sum of the two, is  $2K_h$  and the difference is  $2K_{\ell-1}$ ; hence, the smaller of the two is  $K_\ell - K_{\ell-1}$  while the larger is  $K_\ell + K_{\ell-1}$ . So the difference at this polygon adds up to  $2K'_\ell \tau_\ell$ .  $\square$

**Example 1.** We tabulate in a table the calculations needed to find the Wiener index of the even motley chain shown in Figures 2 and 3.

$h$	0	1	2	3	4	5	6	7	8	9	10	11	12
Top	1	2	0	2	0	0	1	0	1	0	0	2	0
Bottom	1	0	0	0	0	2	3	0	3	0	0	0	0
$k_h$	2	2	1	2	1	2	3	1	3	1	1	2	1
$j_h$	0	-1	0	-1	0	1	1	0	1	0	0	-1	0
$K$		2		5		8	10		14			19	
$K'$		18		15		12	9		5			1	
$\tau$		2		7		3	18		24			5	
$2\tau K'$		72		210		72	324		240			10	

Table A: Calculating the Wiener index of motley chain in Figures 2 and 3.

Total length of the chain is  $K = 22, n_6 = 5, n_8 = 2$ , so:

$$\mathcal{W}(E_0) = \frac{1}{3}(23 \times 25 \times 45) + (5 \times 2 + 2 \times 8) = 8651,$$

$$\mathcal{W}(E) = \mathcal{W}(E_0) - (72 + 210 + 72 + 324 + 240 + 10) = 7723.$$

**Corollary 1.** Assume that the  $k_i$ 's above comprise  $n_4$  ones (squares) and  $n_6$  twos (hexagons) and define its hex-length to be  $N \equiv n_6 + \frac{n_4}{2}$ , we assign to each hex the



monster chain in Figure 7 is quite doable with paper, pencil and a little patience!) is shown below and the reader is invited to compare this with similar calculations in [16].

Hex: <i>i</i>	0	$\frac{3}{2}$	$\frac{5}{2}$	4	5	7	$\frac{17}{2}$
<i>B</i>			•	•	•	•	•
<i>C</i>			•	•		•	
$\nu$			4	5	7	$\frac{17}{2}$	9
$\psi$			$\frac{23}{2}$	9	2	$\frac{5}{2}$	$\frac{1}{2}$
$i\psi(i)$			$\frac{115}{4}$	36	10	$\frac{35}{2}$	$\frac{17}{4}$

$$\begin{aligned}
 W &= \frac{1}{3}(21 \times 23 \times 41) + 2 \times 7 \\
 &\quad - 8 \left\{ \frac{5}{2} \times \frac{23}{2} + 4 \times 9 + 5 \times 2 \right. \\
 &\quad \quad \left. + 7 \times \frac{5}{2} + \frac{17}{2} \times \frac{1}{2} \right\} \\
 &= 6615 - 7 \times \frac{193}{2} \\
 &= 5843
 \end{aligned}$$

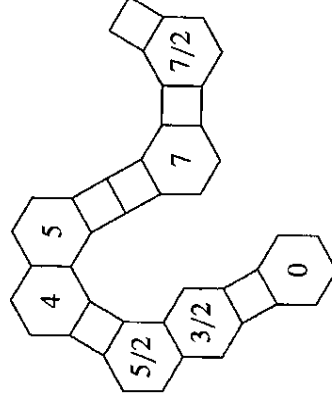

Figure 8. The chain  $\star\Box 12\Box 22\Box\Box 0\Box\Box$ , otherwise written  $212_02_112_12_112_{-1}12_{-1}1$ , and its length is  $N = 10$ .

### 3. Zigzagging chains including odd polygons

We have seen that chains with only even-sided polygons can be handled comprehensively via Equation 2.8. When the situation involves odd-sided polygons, the situation is quite a bit stickier. First of all we need a base value against which Wiener indices of chains can be compared, which means a kind of ‘standard’ chain must be defined—as below.

**Definition 5** (Zigzagging chain). A motley chain is said to be *straight* or *zigzagging* if for one of its representations (as in Definition 3)  $S = (a_1, b_1), \dots, (a_n, b_n)$  the set  $\{\sum_{i=1}^j (a_i - b_i) \mid 1 \leq j \leq n\}$  is contained in  $\{0, 1\}$  or  $\{0, -1\}$ . We will denote

by  $\mathcal{Z}_{n_1, n_2, \dots, n_k}(n)$  the Wiener index of a straight chain consisting of  $n$  repetitions of polygons of  $n_1, n_2, \dots, n_k$  sides. A pictorial representation is given in Figure 9:



Figure 9. A 'straight' motley chain.

And as the following example will demonstrate, the Wiener index of straight chains composed of just odd-sided polygons is relatively straightforward:

**Example 3** (Wiener index of a chain of zigzagging pentagons and septagons). We want to find  $\mathcal{Z}_{5,7}(n)$ , the Wiener index of a straight motley chain composed of alternating pentagons and septagons. To do this, we start with a straight chain of  $n$  decagons, the Wiener index we know from Equation 2.5 to be

$$\mathcal{Z}_{10}(n) = \frac{1}{3}(4n + 1)(4n + 3)(8n + 1) + 20n.$$

Figure 10 should illustrate our method well. We will subdivide each decagon into a pentagon and a septagon starting from one end. Clearly, the distances *between the vertices which comprise each original decagon* changes with the subdivision, as is given by the difference (found from Equation 2.8) between the Wiener number of a  $2(m + n)$ -gon and a  $(2m + 1)$ -gon fused with a  $(2n + 1)$ -gon:

$$\begin{aligned} \Delta(m, n) &\equiv \mathcal{W}(C_{2m+2n}) - \mathcal{W}(((2m - 3), (2n - 3))) \\ &= \mathcal{W}(C_{2(m+n-1)}) - \mathcal{W}(((2m - 4), (2n - 4))) \\ &= mn(m + n) - \frac{1}{2}(m^2 + n^2 + 4mn) + \frac{3}{2}(m + n) - 1, \quad (3.10) \end{aligned}$$

so between the Wiener indices of a Decagon ( $= 125$ ) and a Septagon-Pentagon pair ( $= 107$ ) there is a difference of 18. This difference is the same for each subdivision.

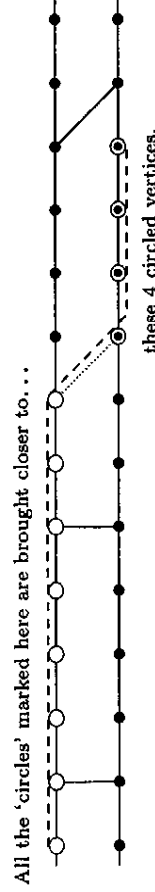

Figure 10. Obtain the Wiener index of a zigzagging penta-septa chain by subdivision.

However, this aside, certain vertices on either side of the divide get closer to each other as shown in Figure 10. One can observe that the distances between two vertices in the graph decreases by one when they are one circled and one gray marked vertices in the figure, *except* for the already-counted cases *when both of the vertices are in the decagon*—which is two times three, or six cases in all here, for each subdivision. We can observe that

- at the beginning of the chain only *two* 'grays' as shown in the figure exist;
- when the  $j$ -th decagon from the end is subdivided there are  $4j - 1$  'circles'.

So we get

$$\mathcal{Z}_{10}(n) - \mathcal{Z}_{7,5}(n) = 12n + 4 \sum_{j=1}^{n-1} (4j - 1) + 2(4n - 1) = 2(2n + 1)^2. \quad (3.11)$$

Similarly for a chain of zigzagging septagons (given that a dodecagon and two septagons differ by  $\Delta(3, 3) = 35$  in terms of Wiener indices) we have:

$$\mathcal{Z}_{12}(n) - \mathcal{Z}_7(2n) = (35 - 3 \times 3)n + 5 \sum_{j=1}^{n-1} (5j - 2) + 3(5n - 1) = 4 + \frac{37n}{2} + \frac{25n^2}{2}. \quad (3.12)$$

It should be obvious now that any 'straight' (that is, zigzagging) polygonal chain made up of an *even* number of *odd-sided* polygons (or one in which the odd-sided polygons pair together nicely) can be handled in the same manner.

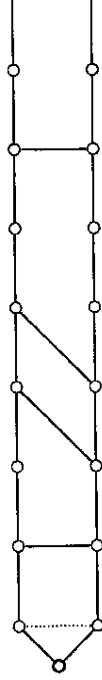

Figure 11. 'Tacking on' an extra at one end of a zigzagging chain.

To see that an *odd* number of odd-siders poses no particular problem either, we show that the Wiener index of a zigzagging septagon-chain can be found painlessly thus: consider the straight even chain  $S = \underbrace{5 \dots 5}_n 2$ , that is,  $n$  dodecagons followed

by an hexagon, and consider the increment in Wiener index when the trailing hex is changed to a septagon—that is, when an extra vertex is tacked onto the end of the chain. The difference is clearly  $15 + 5n(5n + 7)$ , the first term being the difference between  $\mathcal{W}(C_6) = 27$  and  $\mathcal{W}(C_7) = 42$ , and the second being the sum of distances between the tacked-on vertex and the vertices not in the original hex. It can then be seen that this tacked-on vertex does not change its distance to any point in the process of subdivision. Therefore we get  $\mathcal{Z}_7(2n + 1)$  by subdivision of the chain  $S$  above and adding in the difference.



Figure 12. A more general sort of subdivision.

In the previously introduced procedure of subdivision, the most important relation is given by Equation 3.10. To make sure that we can handle any zigzagging chain, in

any arrangement of the polygons, we need to handle a split of a  $2(m+n+k)$ -gon into polygons with  $2m+1$ ,  $2(k+1)$ , and  $2n+1$  sides, in that order. So we need

$$\begin{aligned} \Delta(m, n; k) &\equiv \mathcal{W}(C_{2(m+n+k)}) - \mathcal{W}\left(\left(\binom{k-1}{k-1} \binom{k-1}{1} (2n-3)\right)\right) \\ &= -1 + 2k - k^2 + \frac{3m}{2} - 2km + k^2m - \frac{m^2}{2} + km^2 + \frac{3n}{2} - 2kn \\ &\quad + k^2n - 2mn + 2kmn + m^2n - \frac{n^2}{2} + kn^2 + mn^2. \end{aligned} \quad (3.13)$$

One can see that setting  $k=0$  reduces to Equation 3.10, furthermore having more than one even-sided polygon between the two odd-sided ones present no problem because one can subdivide an even-sided polygon quite easily with the method of the previous section.

**Example 4** (Repeating straight chain). Suppose that we wish to calculate  $Z_{5,6,7}(n)$ . From the above, we start with a chain of  $n$  straight quadracagons which has Wiener index

$$Z_{14}(n) = (2n+1)(6n+1)(12n+1) + 70n.$$

The difference for each subdivision in the 14-gon itself is  $\Delta(2, 3, 2) = 68$ . For the division with  $j$  14-gons left the 'circles' number  $6j-1$ , and there are always six grays (except for 4 at the beginning). Ergo, we have

$$\begin{aligned} Z_{14}(n) - Z_{7,6,5}(n) &= (68 - 5 \times 4)n + 6 \sum_{j=1}^{n-1} (6j-1) + 4(6n-1) \\ &= 18n^2 + 48n + 2. \end{aligned}$$

Hence

$$Z_{7,6,5}(n) = -1 + 42n + 90n^2 + 144n^3. \quad (3.14)$$

#### 4. Wiener indices of generic polygonal chains

Having found a standard Wiener index against which to calculate deviations, we will proceed in a similar fashion to Section 2. However there is one essential difference, viz: when handling even motley chains, every vertex in a chain was *either* closer to one or of its end-vertices (marked '+' and '-') or the other, as depicted by the gray and black dots in Figure 6. Such is not the case when dealing with odd-sided polygons since some (marked as white dots in following 4 figures) may be equi-distant to both end-vertices. More precisely:

**Lemma 3.** *Marking the upper and lower end-vertices of a motley chain as  $u_+$  and  $u_-$  and represent the chain as  $S = \begin{pmatrix} a_1 & a_2 & \dots & a_n \\ b_1 & b_2 & \dots & b_n \end{pmatrix}$  (with the  $a_1, b_1$  side next to the end-vertices). Define  $d_i \equiv a_i - b_i$ ,  $e_i \equiv a_i + b_i + 2$ , and where applicable  $\ell$  the smallest  $i$  for which  $d_i \neq 0$ . Further denote by  $S_+$ ,  $S_-$ ,  $S_0$  the set of non-end vertices closer to  $u_+$ , closer to  $u_-$ , and equidistant respectively. Then when  $d_\ell > 0$  (otherwise just switch the +’s and -’s):*

- If  $d_\ell \geq 2$ , (Figure 13), then

$$|S_+| = \left\lfloor \frac{1}{2} \sum_{j=1}^{\ell} e_j \right\rfloor, \quad |S_0| = (e_\ell \bmod 2), \quad |S_-| = |S_+| + \sum_{j=\ell+1}^n e_j.$$

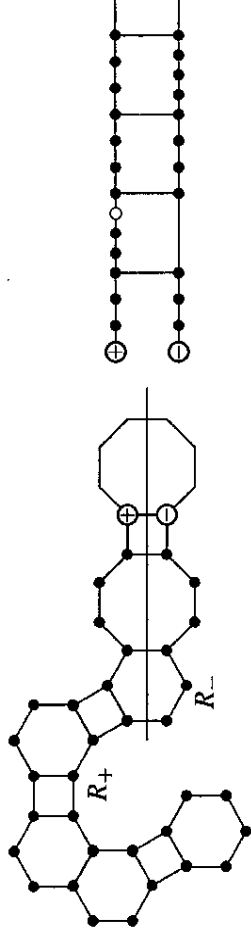

Figure 13. A turn to the right, same as the even-only case.

- If  $d_\ell = 1$ , then  $|S_+| = \left\lfloor \left[ \left( \sum_{j=1}^{\ell} e_j \right) - 1 \right] / 2 \right\rfloor$ , and furthermore:
- if  $d_i = 0$  or 1,  $\forall i > \ell$  (Figure 14, a straight chain), then:

$$|S_0| = \left\lfloor \frac{1}{2} \left( 3 + \sum_{j=\ell+1}^n e_j \right) \right\rfloor, \quad |S_-| = \left\lfloor \frac{1}{2} \left( \sum_{j=1}^n e_j \right) \right\rfloor.$$

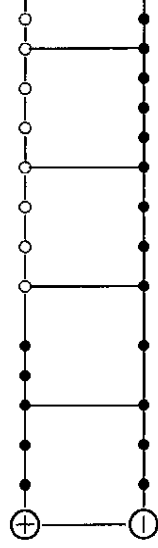

Figure 14. A zigzagging chain and its vertices.

- Suppose  $d_m \geq 2$ , where  $m = \min\{i | d_i \neq 0 \text{ or } 1\}$  (Figure 15), then:

$$|S_0| = \left\lfloor \frac{1}{2} \left( 3 + \sum_{j=\ell+1}^m e_j \right) \right\rfloor, \quad |S_-| = \left\lfloor \frac{1}{2} \left( \sum_{j=1}^m e_j \right) \right\rfloor + \sum_{j=m+1}^n e_j;$$

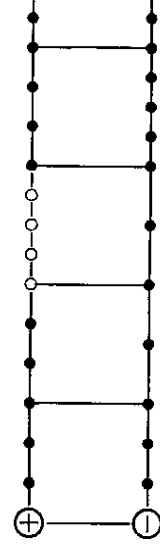

Figure 15. Here the equal-distance portion is transient.

- as above, but if  $d_m < 0$  (Figure 16), then:

$$|S_0| = \left[ \frac{1}{2} \left( 3 + \sum_{j=\ell+1}^m e_j \right) \right] + \sum_{j=m+1}^n e_j, \quad |S_-| = \left[ \frac{1}{2} \left( \sum_{j=1}^m e_j \right) \right].$$

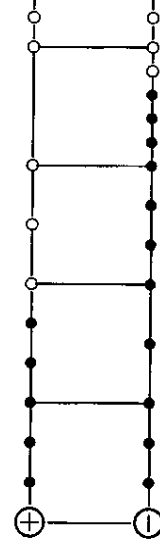

Figure 16. Here most vertices are equidistant to the ends.

- If there is no  $\ell$ , chain is straight even, vertices split evenly between  $S_+$  and  $S_-$ .

*Proof.* Pretty much by inspection.  $\square$

With Lemma 3 under our belt, we can proceed to the following lemma which we will need to derive the Wiener index of a generic motley chain from a straight chain. Before that, however, we need to define our notations. Given any motley chain

$$S = \left\langle \begin{matrix} a_1 & a_2 & \dots & a_n \\ b_1 & b_2 & \dots & b_n \end{matrix} \right\rangle, \quad \text{we can find a chain } S_0 = \left\langle \begin{matrix} x_1 & x_2 & \dots & x_n \\ y_1 & y_2 & \dots & y_n \end{matrix} \right\rangle \text{ which is straight or}$$

*zigzagging* according to Definition 4, and satisfying  $x_i + y_i = a_i + b_i$ ,  $\forall i$ . The *stages*

$$\text{of straightening } S_j = \left\langle \begin{matrix} a_1 & a_2 & \dots & a_j & x_{j+1} & \dots & x_n \\ b_1 & b_2 & \dots & b_j & y_{j+1} & \dots & y_n \end{matrix} \right\rangle \text{ will be defined in direct analogy}$$

to the notations used in Section 2 (one example shown in Figure 17).



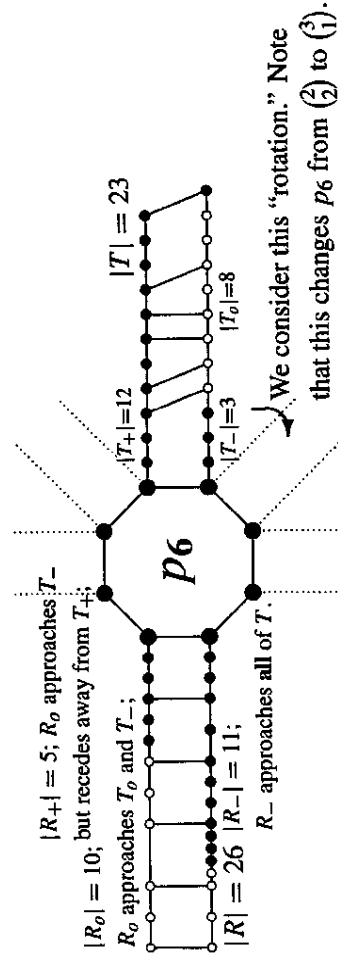

Figure 17.  $p_6$ , a 'stage of the straightening' of a generic motley chain!

**Lemma 4** (Rotation at one polygon). *If we mark the two remaining chains to be  $R$  and  $T$ , the latter being straight (zigzagging), then we need only the following to calculate the difference in Wiener indices between straight motley chain and general positions. Partition  $R$  into three parts  $R_+$ ,  $R_-$ , and  $R_0$  and  $T$  ditto as in the previous lemma, and:*

- If  $x_i = y_i$  and  $x_i - a_i > 0$  (as demonstrated in Figure 17—switch + and — for the opposite case) then

$$\mathcal{W}(S_{i-1}) - \mathcal{W}(S_i) = (x_i - a_i)|R||T| - (|R_0||T_-| + |R_-||T_0| + 2|R_+||T_-|).$$

- If  $x_i - y_i = x_i - a_i = 1$  (Figure 18), then

$$\mathcal{W}(S_{i-1}) - \mathcal{W}(S_i) = (|R_+||T_+| + |R_0||T_+| + |R_+||T_0|) - (|R_-||T_0| + |R_-||T_0| + |R_-||T_-|).$$

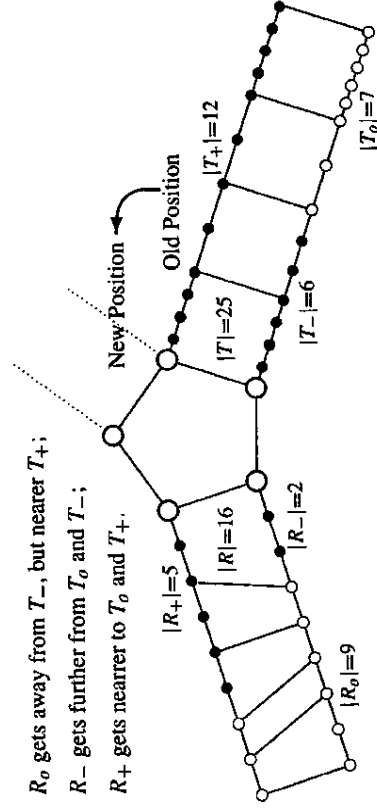

Figure 18. 'Buckling' between bearing up and bearing down!

- If  $x_i - y_i = 1, a_i - x_i > 0$ , then

$$\mathcal{W}(S_{i-1}) - \mathcal{W}(S_i) = (a_i - x_i)|R||T|.$$

Lemma 3 and Lemma 4 are basically sufficient to calculate, by hand if necessary (although somewhat cumbersome), the Wiener number of any motley chain. For chains in which deviations from the straight is not too numerous, the process is quite straightforward, and we will now give a concrete example.

**Example 5.** We will do a very simple illustration with the motley chain in Figure 1 and its straightened form, which can be represented as

$$S = \left\langle \begin{matrix} 3 & 2 & 1 & 0 & 0 \\ 1 & 1 & 2 & 0 & 1 \end{matrix} \right\rangle, \text{ and } S_0 = \left\langle \begin{matrix} 0 & 2 & 2 & 1 & 0 & 1 & 1 \\ 1 & 2 & 1 & 2 & 0 & 0 & 1 \end{matrix} \right\rangle.$$

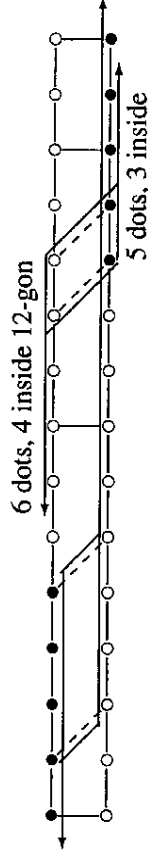

Figure 19. The straightened chain.

So, before the subdivisions are drawn into  $S_0$ , we have an even motley chain of length 14, made up of an hexodecagon, a dodecagon, and a hexagon. Equation 2.5 gives its Wiener index as  $\frac{1}{3}(15 \times 17 \times 29) + 2\binom{6}{3} + \binom{6}{3} + \binom{3}{3} = 2619$ .

The hexodecagon subdivided into a pentagon, an octagon, and a septagon. makes a difference of  $\Delta(2, 3, 3) = 105$ ; the extra difference between rows is  $5 \times 7 = 35$ , for 140 total. The dodecagon subdivided into a septagon, a tetragon, and a pentagon, make a difference of  $\Delta(3, 2, 1) = 39$ ; the extra difference comes to  $6 \times 5 - 4 \times 3 = 18$ , for a total of 57. Finally  $\mathcal{W}(S) = \mathcal{W}(S_6)$  is found via:

$$\mathcal{W}(S_0) = 2619 - 140 - 57 = 2422,$$

$$\mathcal{W}(S_2) = \mathcal{W}(S_0) - 43 = 2379,$$

$$\mathcal{W}(S) = \mathcal{W}(S_2) - 12 = 2367.$$

$i$	1	2	3	4	5	6	7
$x_i$	0	2	2	1	0	1	1
$y_i$	1	2	1	2	0	0	1
$e_i$	3	6	5	5	2	3	4
$ T_- $		9	2	4		2	
$ T_0 $		8	6	3		0	
$ T_+ $		2	6	2		2	
$a_i$	0	3	2	1	0	0	1
$b_i$	1	1	1	2	0	1	1
$ R_- $		1	6	2		3	
$ R_0 $		1	0	4		9	
$ R_+ $		1	3	8		9	

## 5. Discussion

So far as we know, this is the first attempt on systemic calculation of Wiener indices of arbitrary polygonal chains. Perceptive readers should have by now realised that

even though Sections 3 and 4 are mostly in examples, the procedure thus outlined actually contains a generally applicable algorithm which takes considerably less actual computation time than a brute-force recursion approach—even though a complete description would be tedious and too long in view of space limitations.

The eagle-eyed reader would also have spotted the fact that despite the original 'chemical' definition of 'catacondensed' polygonal chains (as used in [16] and [39]) not allowing vertices of degree 4, but the contents of this article apply to them with equal force. To be quite precise, they correspond to motley chains that have some of the  $a_i$  or  $b_i$  being  $-1$ , but not both in a pair at the same time (since the smallest polygon that is meaningful is the triangle). Most formulas in the text apply with undiminished validity!

**Acknowledgements.** The authors are greatly indebted to National Science Council of Taiwan (R. O. China) for financial support under Grants NSC84-2121-M-032-006 and NSC84-2121-M-001-009 respectively.

## References

- [1] D. Bonchev, Information theoretic indices for characterization of chemical structure, Research Studies Press, Chichester 1983.
- [2] D. Bonchev and O. Mekenyan, Comparability, Graphs and Molecular Properties, J. Chem. Soc. Faraday II, 80 (1983), 695.
- [3] F. Buckley and F. Harary, Distances in Graphs, Addison-Wesley, New York 1990.
- [4] J.-C. Chen, I. Gutman and Y. Yeh, On the sum of all distances in graphs, Tamkang J. of Mathematics 25 (1993), 83–86.
- [5] I. Gutman and O. E. Polansky, Mathematical concepts in organic chemistry, Springer-Verlag, Berlin 1986.
- [6] I. Gutman, Wiener numbers of benzenoid hydrocarbons: Two theorems, Chem. Phys. Letters 136 (1987), 134–136.
- [7] I. Gutman, J. W. Kennedy and L. V. Quintas, Wiener numbers of random benzenoid chains, Chemical Physics Letters 173 (1990), 403–408.
- [8] I. Gutman, S.-L. Lee, Y.-L. Luo and Y. Yeh, Recent results in the theory of the Wiener number, Indian J. Chem. 32A (1993), 651–661.
- [9] I. Gutman and D. H. Rouvray, A new theorem for the Wiener branching index of trees with perfect matchings, to appear in Computers and Chemistry.
- [10] I. Gutman and Y. Yeh, On the sum of all distances in composite graphs, to appear in Discrete Math.
- [11] F. Harary, Graph Theory, Addison-Wesley, Reading, MA, 1971.
- [12] F. Harary, Status and contrastatus, Sociometry 22 (1959), 23–43.

- [13] H. Hosoya, Topological index. A newly proposed quantity characterizing the topological nature of structural isomers of saturated hydrocarbons, *Bull. Chem. Soc. Japan* 44 (1971), 2332-2339.
- [14] H. Hosoya, On some counting polynomials in Chemistry, *Discrete Appl. Math.* 19 (1988), 239-254.
- [15] I.-W. Huang, B.-Y. Yang, and Y. Yeh, Wiener Indices of Hex Carpets—from Hexagon Models to Square Grids, preprint.
- [16] W.-C. Huang, B.-Y. Yang, and Y. Yeh, From ternary Strings to Wiener Indices of Bezenoid Chains, preprint.
- [17] S.-L. Lee and C.-Y. Lin, Graph Theory and Chemistry, *Chinese Chem. Soc. (of Taiwan)* 49 (1991), 179-187.
- [18] I. Lukovits, Correlation between Components of the Wiener Index and Partition Coefficients of Hydrocarbons, *Internat. J. Quantum Chem. and Quantum Biol. Symposium* 19 (1992), 247.
- [19] R. Merris, Laplacian Matrices of Graphs: a Survey, preprint.
- [20] R. Merris, An edge version of the matrix-tree theorem and the Wiener Index, *Linear and Multilinear Algebra* 25 (1989), 291-296.
- [21] Z. Mihalić, D. Vejšan, D. Armić, S. Nikolić, D. Plavšić, and N. Trinajstić, The Distance Matrix in Chemistry, *J. Math. Chem.* 11 (1992), 223-258.
- [22] B. Mohar, Eigenvalues, Diameter, and Mean Distance in graphs, *Graphs Combin.* 7 (1991), 53-64.
- [23] B. Mohar and T. Pisanski, How to compute the Wiener index of a graph, *J. Math. Chem.* 2 (1988), 267-277.
- [24] I. Motoc and A. Balaban, Topological indices: intercorrelation, physical meaning, correlational ability, *Revue Roumaine de Chimie* 26 (1981), 593-600.
- [25] J. Plesnik, On the sum of all distances in a graph or digraph, *J. Graph Theory* 8 (1984), 1-21.
- [26] K. S. Pitzer, The Volumetric and Thermodynamic Properties of Fluids. Theoretical Basis and Virial Coefficients, *J. Amer. Chem. Soc.* 77 (1955), 3427.
- [27] D. H. Rouvray, On the sum of distance matrix elements, in: *Chemical Applications of Graph Theory* (A. T. Balaban, ed.), Academic Press, New York 1976.
- [28] D. H. Rouvray, The role of the topological distance matrix in chemistry, in: *Mathematics and Computational Concepts in Chemistry* (N. Trinajstić, ed.), Horwood Publishers, Chichester 1986, 295-306.
- [29] D. H. Rouvray, The modelling of chemical phenomena using topological indexes, *J. Comput. Chem.* 8 (1987), 470-480.
- [30] D. H. Rouvray, The challenge of characterizing molecular branching in molecular species, *Discrete Appl. Math.* 19 (1988), 317-338.
- [31] E. Ruch and I. Gutman, The Branching Extent of Graphs, *J. Combin. Inform. System Sci.* 4 (1979), 285-295.
- [32] B. E. Sagan and Y. Yeh, The Wiener Polynomial of a Graph, preprint.

- [33] L. Šoltés, Transmission in graphs: a bound and vertex removing, *Math. Slovaca* 41 (1991), 11–16.
- [34] H.-H. Teh and S.-C. Shee, Algebraic Theory of Graphs, Lee Kong Chian Inst. of Math. and Comp. Sci. Nanyang Univ. Singapore.
- [35] H. Wiener, Structural determination of paraffin boiling points, *J. Amer. Chem. Soc.* 69 (1947), 17–20.
- [36] H. Wiener, Correlation of Heats of Isomerization and Differences in Heats of Vaporization of Isomers, among the Paraffin Hydrocarbons, *J. Amer. Chem. Soc.* 69 (1947), 2636.
- [37] H. Wiener, Vapor Pressure—Temperature Relationships among the Branched Paraffin Hydrocarbons, *J. Phys. Chem.* 52 (1948), 425.
- [38] H. Wiener, Relation of the Physical Properties of the Isomeric Alkanes to Molecular Structure, *J. Phys. Chem.* 52 (1948), 1082.
- [39] B.-Y. Yang, and Y. Yeh, Zigging and Zagging in Pentachains, to appear in *Adv. in Appl. Math.*

Department of Mathematics  
Tamkang University  
Tamsui  
Taipei County, Taiwan, ROC

Institute of Mathematics  
Academia Sinica  
Nankang  
Taipei City, Taiwan, ROC